

# ROPOS

CANADIAN SCIENTIFIC SUBMERSIBLE FACILITY

# SCIENCE FIRST.

A global leader in remotely operated submersible systems.

## SCIENCE DRIVEN.

Our world-class ROV is designed for science-based research missions and piloted by the most experienced technicians available.

## SCIENCE READY.

Our ROV is designed and equipped with leading edge technology, premium HD video cameras and instrumentation.

## SCIENCE NOW.

With our technology and tools, fewer ship days are required and multiple experiments can be conducted at one time. Deployment is also fast and efficient.

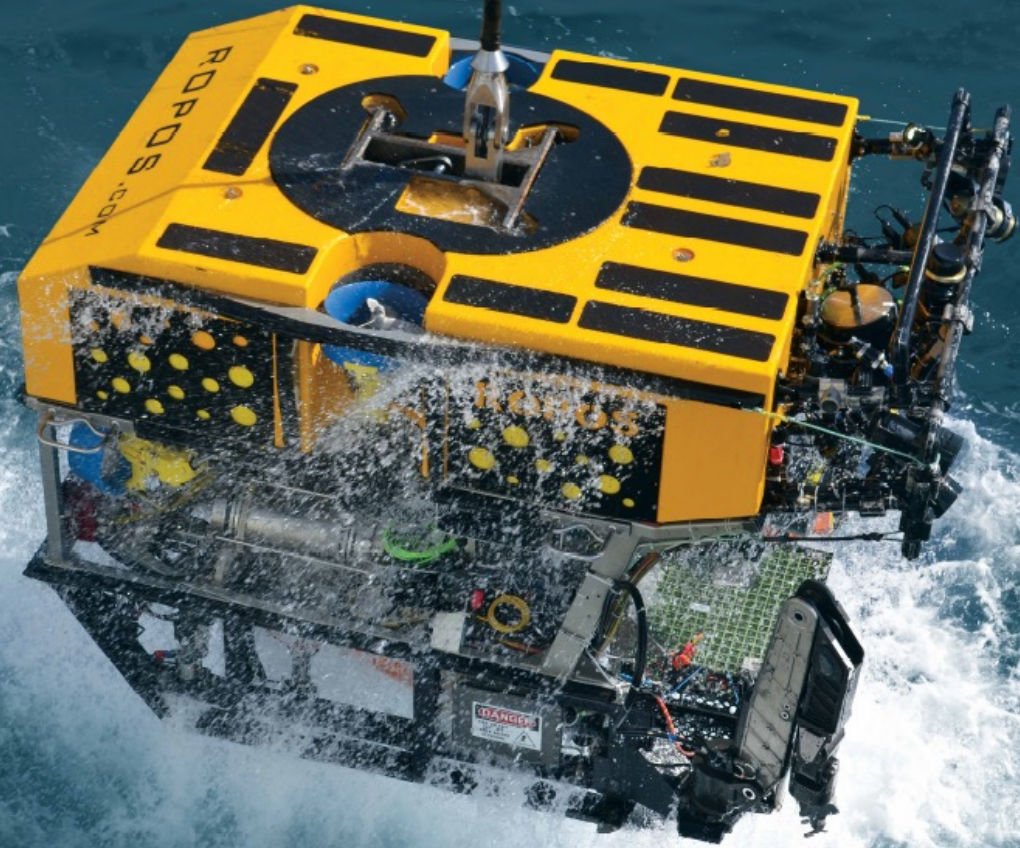

- Not-for-Profit - user pay facility
- Experienced operators and mature systems increasing efficiency
- Reliable – 98% Uptime - Minimal Maintenance Time
- State of the art technology
- Flexible System Options, i.e. Docking Head A-frame operations to full depth

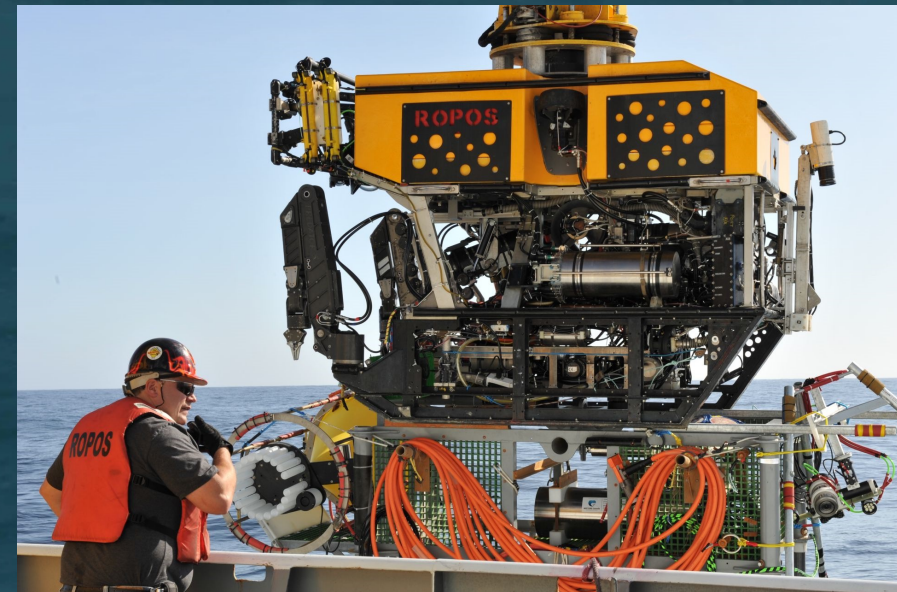

## SYSTEM OPTIONS



### 1000M COASTAL SYSTEM

- Uses a small synthetic-tether winch
- Can be operated from vessels as small as ~100 ft long



### 4000M WITH A-FRAME DOCKING HEAD

- Highly cost-effective
- Can be operated from a coastal class (regional scale) vessel



### 4000M WITH LAUNCH & RECOVERY SYSTEM

- Increased weather window
- Reduced deck-crew requirements
- Typically used with a global class vessel

## VESSEL DIVERSITY



- NOAA Ship Henry Bigelow – 210ft
- NOAA Ship McArthur II – 224ft
- R/V Atlantis – 273ft
- R/V Thomas G. Thompson – 275ft
- NOAA Ship Ronald H. Brown – 275ft
- NOAA Ship Discoverer – 303ft
- CS Dependable – 456ft



- CCGS RB Young – 105ft
- CCGS Vector – 131ft
- HMCS Dawson – 205ft
- CCGS Parizeau – 211ft
- CCGS Tully – 226ft
- CFAV Quest – 235ft
- HMCS Endeavour – 236ft
- CCGS Martha Black – 272ft
- CCGS Hudson – 296ft
- M/V Kigoriak – 298ft



- R/V Pelagia (Netherlands) – 216ft
- R/V Tan Kah Kee (China) – 254ft
- R/V Falkor (Cayman Islands) – 272ft
- RRS James Clark Ross (United Kingdom) – 324ft
- R/V Sonne (Germany) – 387ft
- CS Giulio Verne (Italy) 436ft
- R/V Akademik Tryoshnikov (Russia) – 439ft

## MISSION HIGHLIGHT - NOAA SHIP BIGELOW 2014, 2017, 2019, 2024

- Operations on this vessel to 3000m
- Full depth capability (4000m) & comprehensive sampling
- Docking Head (A-Frame) Operations w/ or w/o Container Lab
- Excellent hybrid option for ~200ft vessels (regional scale)
- Surveyed canyon, slope, and basin areas, with concurrent sampling of environmental factors (i.e., depth, salinity, temperature, dissolved oxygen)
- Assessed & collected deep-sea corals for analyses on abundance, distribution, size, taxonomic classifications, reproduction, age, genetic studies;

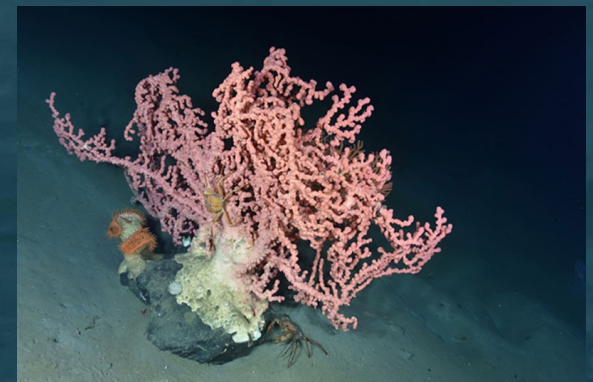

## MISSION HIGHLIGHT – CCGS VECTOR 2005 TO 2017

- Up to 1000m depth
- Overboard sheave operations, stacked winch & levelwind
- Excellent option for very small vessels
  - Requires as little as ~150 square feet of deck space<sup>1</sup>
- Still provides comprehensive sampling suite:
  - Core tubes, water sampling, suction sampling, bioboxes, etc.



<sup>1</sup> Assuming adequate ship specifications (power, lab space, hydraulics, etc.)

## MISSION HIGHLIGHT – **KOREAN RV ISABU 2023, 2024**

- Indian Ocean and Western Pacific
- Operations to 4000m & comprehensive sampling
- Assessed & collected deep-sea geological samples including use of a new coring drill
- Incredible ship



## SCIENCE CAPABILITIES

- Multi-disciplinary dives
- World-leading HD Video
- CTD with pH and O<sub>2</sub>
- Core tubes
- Water Sampling
- Variable-speed suction sampling
- High Temperature Probes
- Gastight Samplers
- ... and more

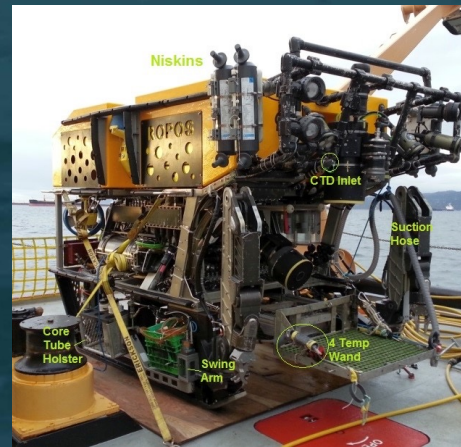
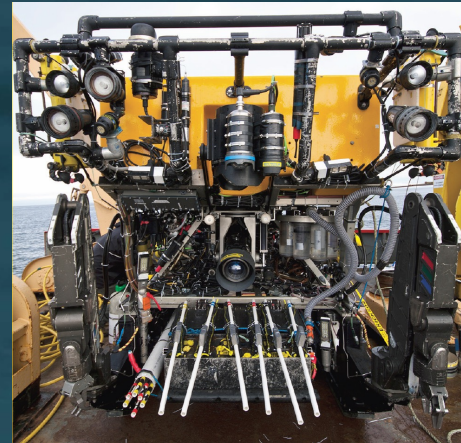
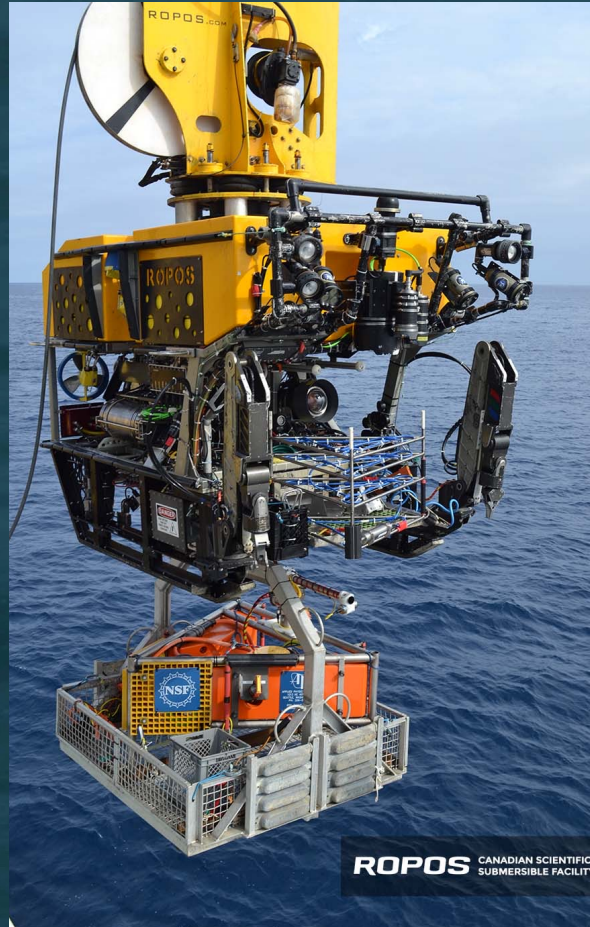



## RECENT IMPROVEMENTS

1. Star Link high bandwidth ship/shore communications acquired and deployed.
2. Nikon 29 Camera has been delivered and pressure tested to 5,000 m. Should deploy this June in NOAA Bigelow. HD, 4k, and 8k resolutions.
3. Later this year there will be significant upgraded to fiber optic systems to better deal with increased data flow.
4. Two coring drills built for two different clients for specific uses down to 4,000 metres.

ROPOS



# Questions?

ROPOS.COM



# THANK YOU

VISIT US AT: [WWW.ROPOS.COM](http://WWW.ROPOS.COM)

# APPENDICES

## DOCKING HEAD

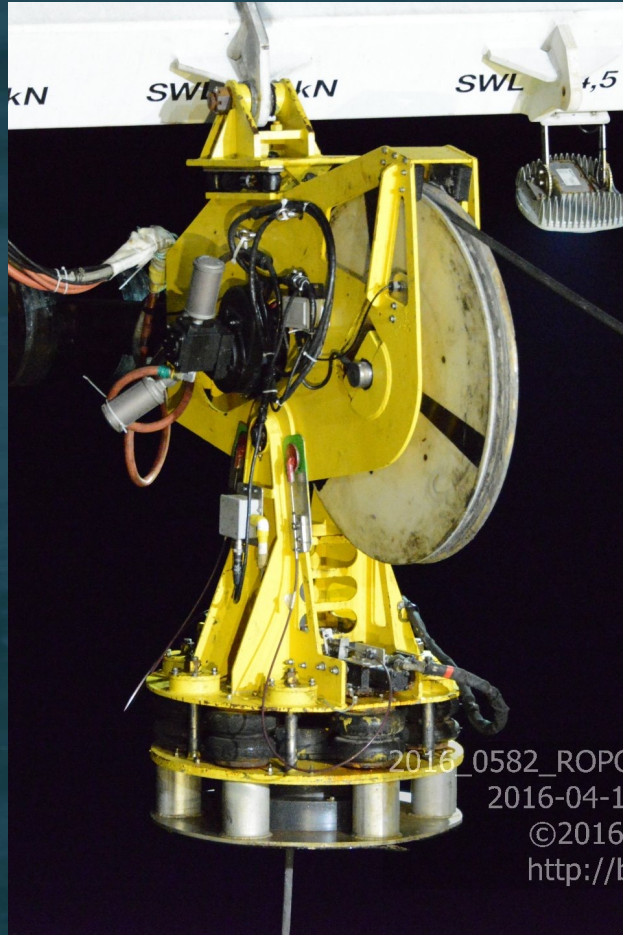

## FIBER OPTIC GYROCOMPASS & DOPPLER VELOCITY LOG



2016\_1502\_ROPOS\_Falkor\_Fiji\_Ops.JPG  
2016-04-23 04:01:08 PST



## NEW DIGITAL STILL CAMERA

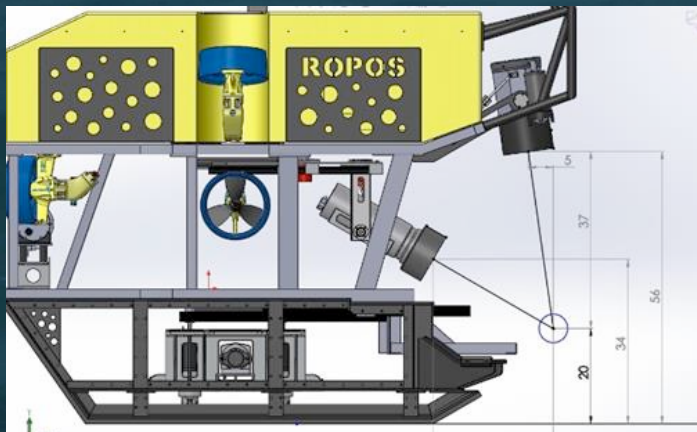
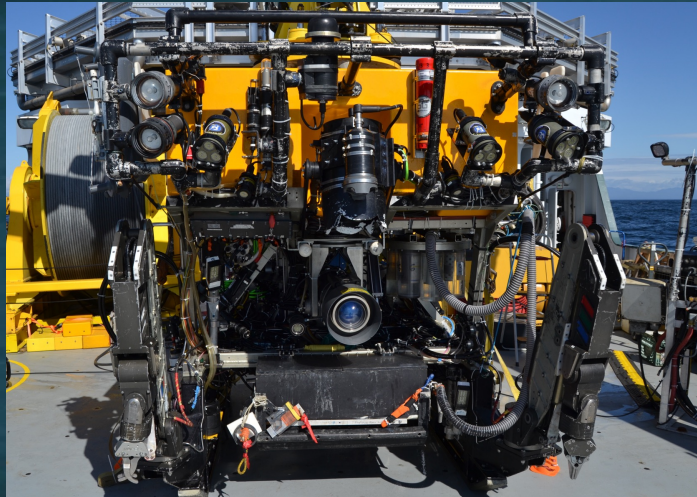

## DRUM/CABLE OPTIONS

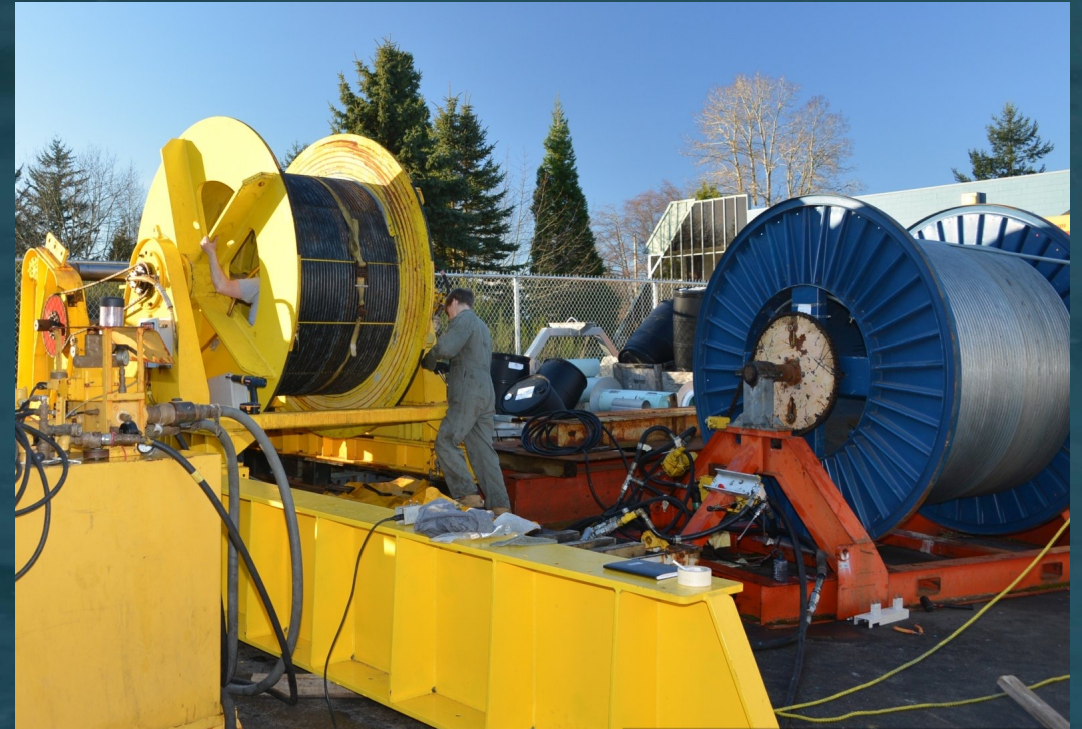
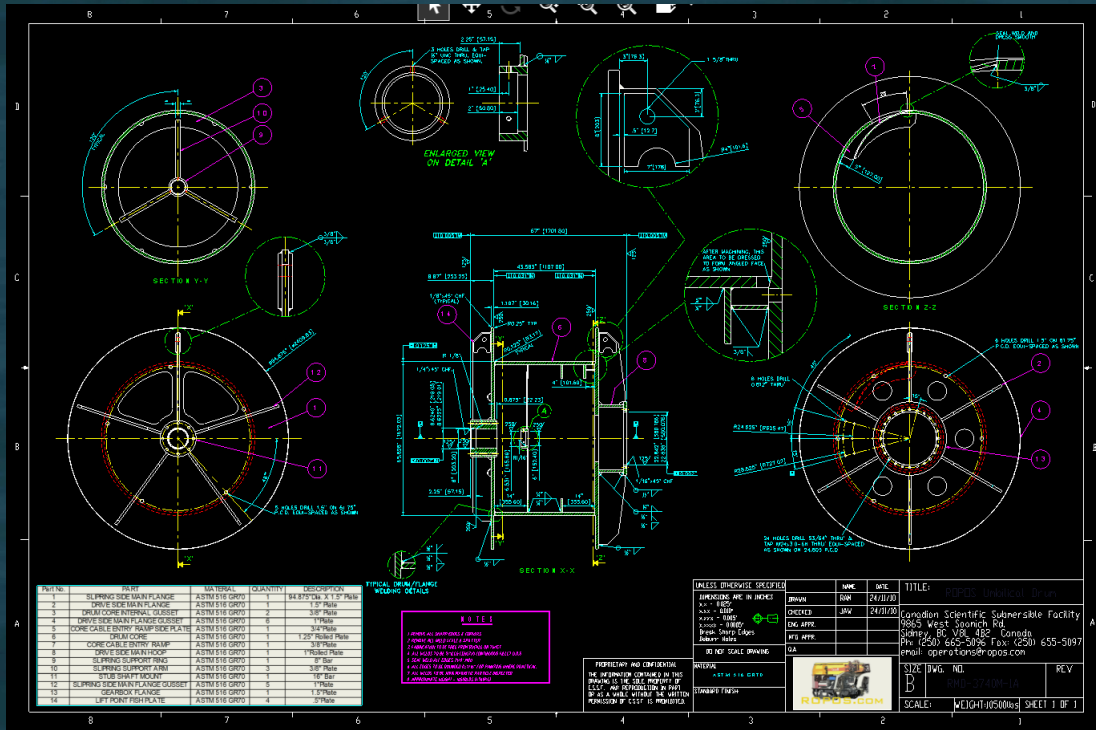



## STATE-OF-THE-ART TELEMETRY

The screenshot displays a comprehensive telemetry interface for the ROPOS submersible. At the top, a status bar includes icons for Signal Mapper, Alarm Manager, Control, Nav, ROPOS, PDU, Joybox, and Ship Pos, along with an 'Acknowledge All Alarms' button and a yellow 'Auto X < -2 m' indicator. The GREENSEA logo is visible in the top right.

The central panel features a map with a grid (10m size) showing the ROV's position and a series of waypoints (12N to 14N). The ROV's current coordinates are ROV: -20.6822811 -176.1835522 and Topside: -20.6817386 -176.1824601.

On the left, a circular heading indicator shows a heading of 178.8 degrees. Below it, ROV Turns are at -0.3. Depth (m) is 2234.6 and Alt (m) is 3.6. Autopilot settings for Station Keeping and Waypoint Following are shown, along with manual controls for HDG (0.5°), XY (0.5m), and Z (1.0m). Auto Heading is set to 178.3, Auto Depth to 2234.7, and Auto Alt. is also present.

On the right, a 'Vehicle' status panel shows 'Altitude Source' (Altimeter and DVL) and 'Attitude Source' (Compass and IMU). Vertical Velocities (ROV: 0.04, Winch: 0.00) and Payout (Meters: 2291.50, Tension (lbs): 7746.00) are displayed. Ship Turns are 0.0 and Relative Turns are -0.3. Vehicle status includes COG 2.77 and SOG (KTS) 0.47.

At the bottom, a table lists waypoints with their names, mission status, and coordinates:

Name	In Mission	Lat / Lon
12N	✓	-20.6810600 -176.1823480
12S	✓	-20.6828800 -176.1822680
13N	✓	-20.6828800 -176.1825500
13S	✓	-20.6810600 -176.1826350
14N	✓	-20.6810520 -176.1829220

Additional panels include 'Effort vs. Speed', 'Head Toward Waypoint', and 'Waypoint Includes Z'. A vehicle status display at the bottom right shows a top-down view of the ROV with heading indicators: -24, 28, -30, and -25.



## HYDRAULIC POWER

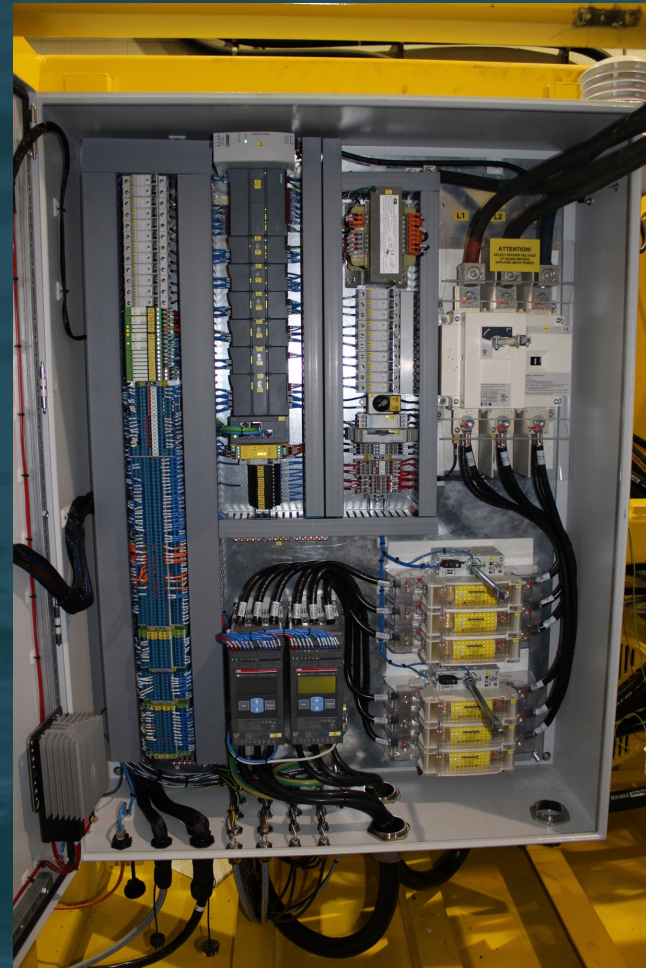

## CONTAINERS & POWERCUBE



2017\_5725\_ROPOS\_Martha\_Black\_Quebec\_City.JPG  
2017-09-19 06:43:02 PST  
©2016 Ray Morgan  
<http://bcmarina.com>

