



Tritium Laboratory  
07 December 2018

SWAB REPORT #921

SWAB DATE: 30 November 2018

*R/V Atlantis and WHOI Rad Van #625.6.03*

---

James D. Happell  
Associate Research Professor

Distribution:  
SWAB Committee  
David Fisichella

## COMMENTS TO SWAB REPORTS

12 May 2014

Typical LSC instrument background values for  $^3\text{H}$  and  $^{14}\text{C}$  are 2 and 5 cpm, respectively. The LSC is a Tricarb 2910 TR with the low level counting option.

All samples are counted for 60 minutes, the instrument background is subtracted, and activities are reported in  $\text{dpm}/\text{m}^2$ . Bucket blank activities are not subtracted. Counting errors (2 standard deviations) are also reported in  $\text{dpm}/\text{m}^2$ . An error larger than the activity indicates that the activity is not significantly different from zero.

### Criteria for SWAB Results

Category	$^3\text{H}$ ( $\text{dpm}/\text{m}^2$ )	$^{14}\text{C}$ ( $\text{dpm m}^2$ )	Recommendations
A	<500	<50	No action
B*	500-10,000	50-10,000	Needs cleaning before any natural tracer work. Decks in radiation vans with activities above $1000 \text{ dpm}/\text{m}^2$ should be cleaned.
C**	10,000-100,000	10,000-50,000	Must be cleaned before any use.
D***	>100,000	>50,000	May be a health hazard. Notify local radiation safety official.

Note:  $^{14}\text{C}$  and  $^{35}\text{S}$  have peak energies of 156 and 167 KeV, respectively; thus  $^{35}\text{S}$  will be registered as  $^{14}\text{C}$  by our counting techniques. Categories A, B and C are not a health hazard.

### Recommended Cleaning Procedure

Wearing ordinary household rubber gloves:

$^3\text{H}$ : Wash and scrub with radioactive cleanup detergent such as COUNT-OFF (50 ml COUNT-OFF to 4 liters of water), using sponges to distribute solution and reabsorb it.

$^{14}\text{C}$ : Wash with 1% sulfuric or 2% hydrochloric (muriatic) acid with good ventilation (will dissolve carbonates, releasing  $^{14}\text{CO}_2$ ). Follow up with wash as if for  $^3\text{H}$ .

### Disposal of Cleaning Materials (gloves, sponges, etc)

Categories A & B dispose as ordinary garbage, C & D contact your institution's radiation safety office.

Note: If category C or D is encountered, we try to notify the institution promptly by phone or email.

REPORT FOR SWAB # 921

LOCATION: Manzanillo, Mexico  
VESSEL/LAB: R/V Atlantis

DATE: 30 November 2018  
TECHNICIAN: Charlene Grall

Sample #	Sample Identification	<sup>3</sup> H dpm/m <sup>2</sup>		<sup>14</sup> C dpm/m <sup>2</sup>	
		activity	error	activity	error
1	1st Vial Bkgnd	0	± 0	0	± 0
2	Initial bucket blank	-2	± 21	12	± 38
	<u>Main Lab (Figure 1)</u>				
3	Port sink area	-26	± 162	-14	± 45
4	Port entrance aft of sink	-16	± 83	13	± 40
5	Port entrance forward of sink	-2	± 53	8	± 38
6	Forward benchtop starboard of copier	28	± 174	-41	± 77
7	Starboard refrigerator bottom only	-11	± 58	0	± 2
8	Deck in front of -80°C freezers	-9	± 0	-1	± 6
9	Benchtop between ice machine & -80°C freezer	-57	± 80	-8	± 46
10	Bechttop across from starboard sink	4	± 183	-6	± 34
11	Starboard sink area	0	± 2	20	± 38
12	Inside fume hood	-91	± 123	-5	± 28
13	Deck inside aft entrance	-27	± 165	-3	± 20
14	Deck inside aft port entrance	4	± 60	-1	± 7
15	Center aft benchtop	14	± 52	-1	± 6
16	Deck in front of port sink	14	± 73	-9	± 51
	<u>Bio Analytical Lab (Figure 2)</u>				
17	Forward sink area	-24	± 146	-2	± 12
18	Forward benchtop	-9	± 47	-15	± 47
19	Deck inside starboard entrance	-37	± 49	1	± 6
20	Starboard benchtop	-26	± 163	-11	± 33
21	Deck inside aft entrance	-24	± 148	-16	± 52
22	Aft sink area	-18	± 91	-18	± 56
23	Inside fume hood	-81	± 109	11	± 60
24	Inside forward refrigerator	-32	± 43	22	± 41
25	Inside forward freezer	33	± 46	14	± 33
26	Deck in front of forward sink	19	± 384	-34	± 63
	<u>Walk-in Coolers (Figure 3)</u>				
27	Floor of forward freezer	-27	± 164	5	± 53
28	Floor of aft freezer	21	± 85	-16	± 51
29	Deck at entrance to walkin freezer area	37	± 49	6	± 28

Sample #	Sample Identification	<sup>3</sup> H dpm/m <sup>2</sup>		<sup>14</sup> C dpm/m <sup>2</sup>	
		activity	error	activity	error
	<u>Computer Lab (Figure 4)</u>				
30	Deck inside forward entrance	-7	± 37	7	± 39
31	Deck inside starboard entrance	-14	± 74	-26	± 49
	<u>Hydro Lab (Figure 5)</u>				
32	Inside refrigerator	-10	± 52	17	± 39
33	Inside Frigidaire freezer	-4	± 203	2	± 42
34	Deck below starboard sink area	-24	± 149	8	± 44
35	Deck below port sink area	3	± 159	-26	± 50
36	Deck of ROV Hanger	-15	± 78	6	± 42
	<u>Wet Lab (Figure 6)</u>				
37	Forward sink area	21	± 112	-26	± 50
38	Inside fume hood	0	± 2	-24	± 45
39	Port benchtop	4	± 97	-7	± 43
40	Starboard benchtop	-35	± 47	-18	± 56
41	Deck in center of lab	10	± 50	-25	± 46
42	Intermediate bucket blank	-14	± 75	-6	± 35
	<u>WHOI Rad Van 625.6.03 (Figure 7)</u>				
43	Sink area	*2897	± 142	*990	± 59
44	Benchtop adjacent to sink	*2966	± 146	*922	± 57
45	Inside fume hood	*3759	± 172	*692	± 49
46	Inside fridge	*6423	± 218	*739	± 45
47	Inside Freezer	*9061	± 260	*474	± 32
48	Benchtop adjacent to LSC	*2756	± 143	*582	± 47
49	Benchtop across from Haier refrigerator	*6124	± 202	*1834	± 73
50	Inside Haier refrigerator	*2181	± 106	*2874	± 96
51	Benchtop across from sink	*2830	± 146	*431	± 41
52	Deck below fume hood	*3714	± 159	*1492	± 69
53	Deck between sink and entrance	*5823	± 203	*983	± 54
54	Final bucket blank	399	± 72	36	± 24

### Comments

Please note that the error reported for each isotope is the two-standard deviation counting error. The reports may now contain values less than zero. When decay counting background samples will be distributed about the background vial, which means that negative values are possible. In the past we rounded the negative values to zero. Values are only significantly above background when they are positive and larger than the error. All areas tested on the ship are free from contamination that requires cleaning. Minor <sup>14</sup>C and <sup>3</sup>H contamination was found in every sample collected in the Rad Van. While no action is needed, we suggest that the decks should be cleaned to help prevent tracking contamination outside the van. It is unusual that every sample from Rad Van was contaminated.

**KEY**

- FIRE EXTINGUISHER
- SCIENCE SEA WATER
- SHIP EQUIP - KEEP CLEAR
- EMERGENCY ESCAPE BREATHING DEVICE
- COMPUTER HUB
- CABLE PASS THRU
- COMPRESSED AIR
- 72" POWER STRIP, 6 PLUGS

UNISTRUT:  
 BULKHEADS  
 2 FT SPACING  
 OVERHEAD FORE/AFT  
 FULL LENGTH OF LAB  
 ALL POWER CLEAN UNLESS NOTED

Figure 1  
 SWAB 921  
 30 November 2018

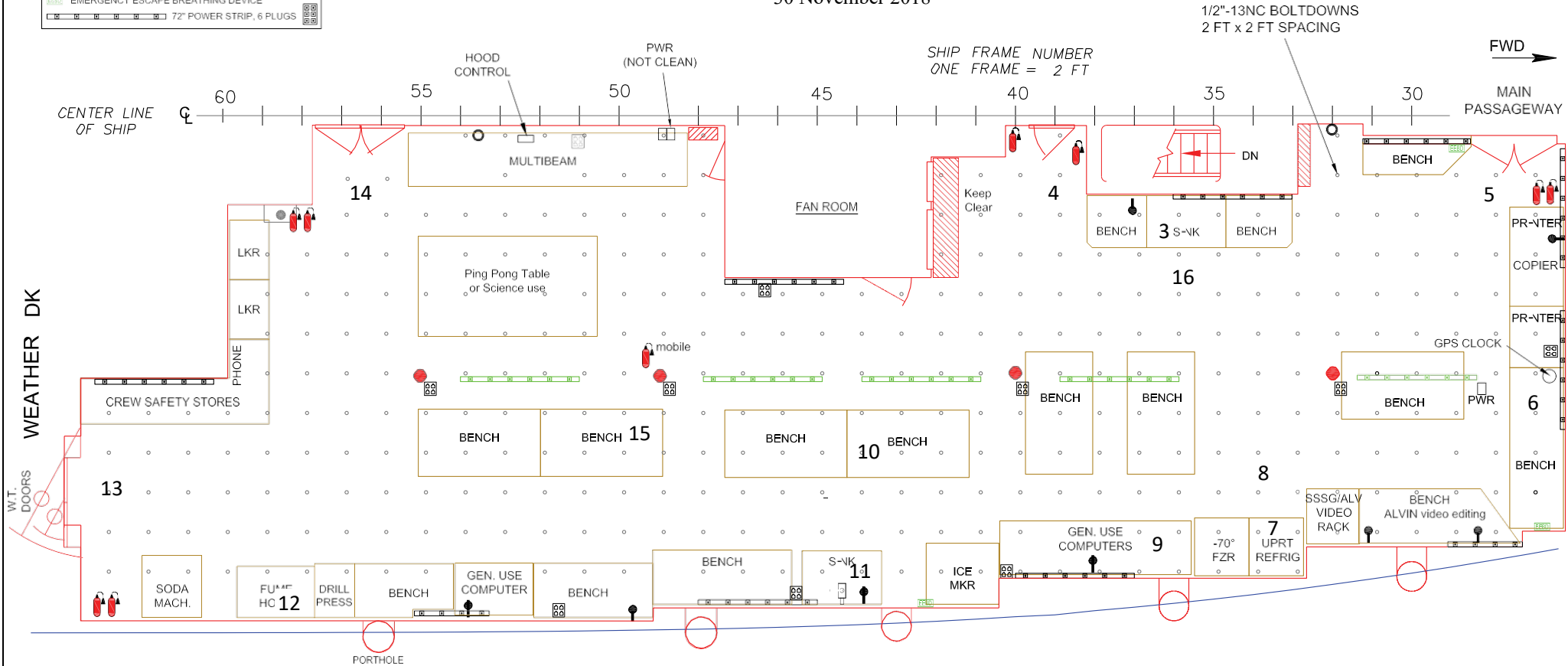

MAIN LABORATORY  
 Atlantis Main Deck, Room 1-26-1

**KEY**









-  FIRE EXTINGUISHER
-  SCIENCE SEA WATER
-  COMPUTER HUB
-  CABLE PASS THRU
-  SHIP EQUIP -KEEP CLEAR
-  COMPRESSED AIR
-  EMERGENCY ESCAPE BREATHING DEVICE
-  72" POWER STRIP, 6 PLUGS

Figure 2  
SWAB 921  
30 November 2018

UNISTRUT:  
BULKHEADS  
2 FT SPACING  
OVERHEAD FORE/AFT,  
FULL LENGTH OF LAB

ALL POWER CLEAN UNLESS NOTED

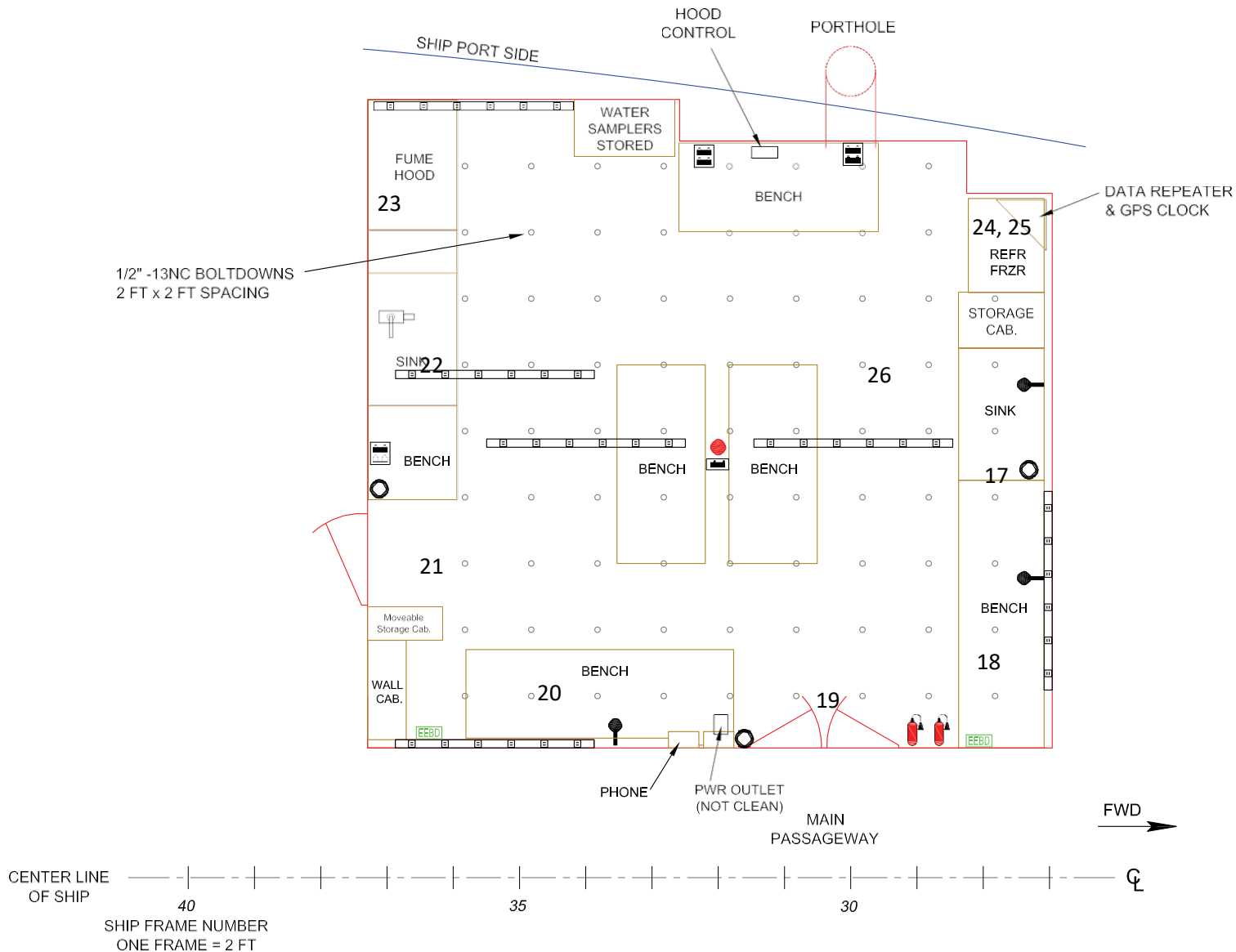

**BIOLOGICAL/ANALYTICAL CLEAN LABORATORY**  
*Atlantis Main Deck, Room 1-27-2*

Figure 3  
 SWAB 921  
 30 November 2018

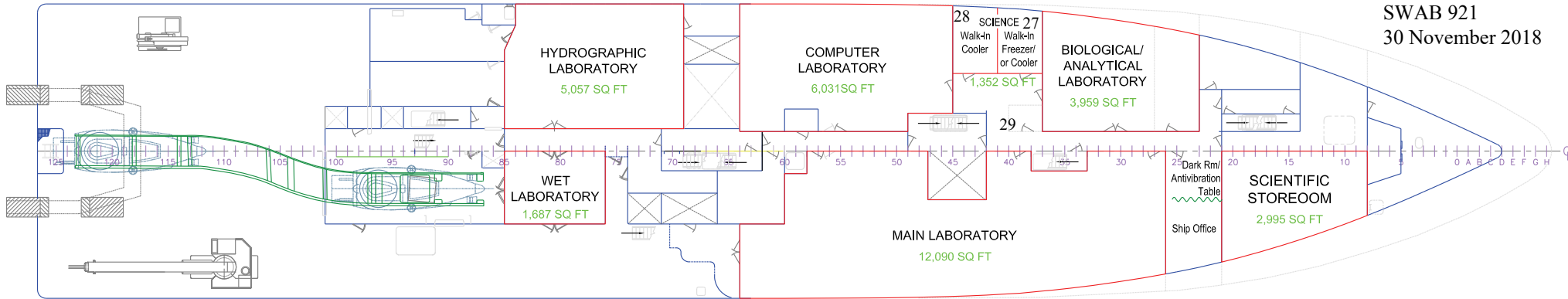

*Laboratories & Scientific Storeroom General Locations  
 Atlantis Main Deck*





**KEY**

 COMPUTER HUB

 SHIP EQUIP -KEEP CLEAR

 EMERGENCY ESCAPE BREATHING DEVICE

 72" POWER STRIP, 6 PLUGS

-  FIRE EXTINGUISHER
-  SCIENCE SEA WATER
-  CABLE PASS THRU
-  COMPRESSED AIR

UNISTRUT:  
BULKHEADS  
2 FT SPACING  
OVERHEAD FORE/AFT,  
FULL LENGTH OF LAB

ALL POWER CLEAN UNLESS NOTED

Figure 4  
SWAB 921  
30 November 2018

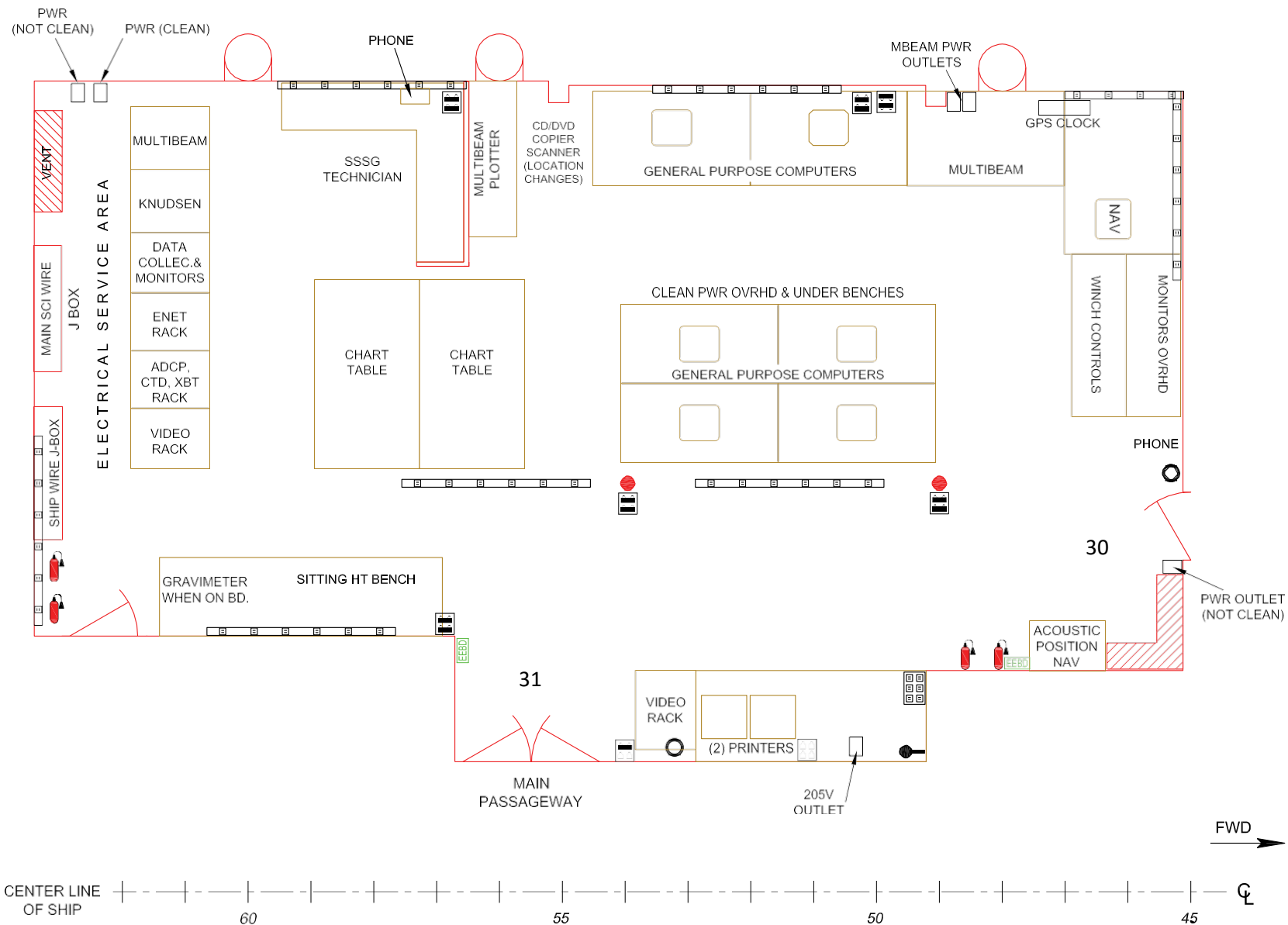

**COMPUTER LABORATORY**  
*Atlantis Main Deck, Room 1-45-2*

SHIP FRAME NUMBER  
ONE FRAME = 2 FT





FULL LENGTH OF LAB  
ALL POWER CLEAN UNLESS NOTED



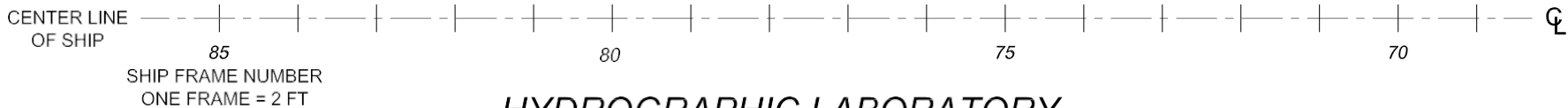
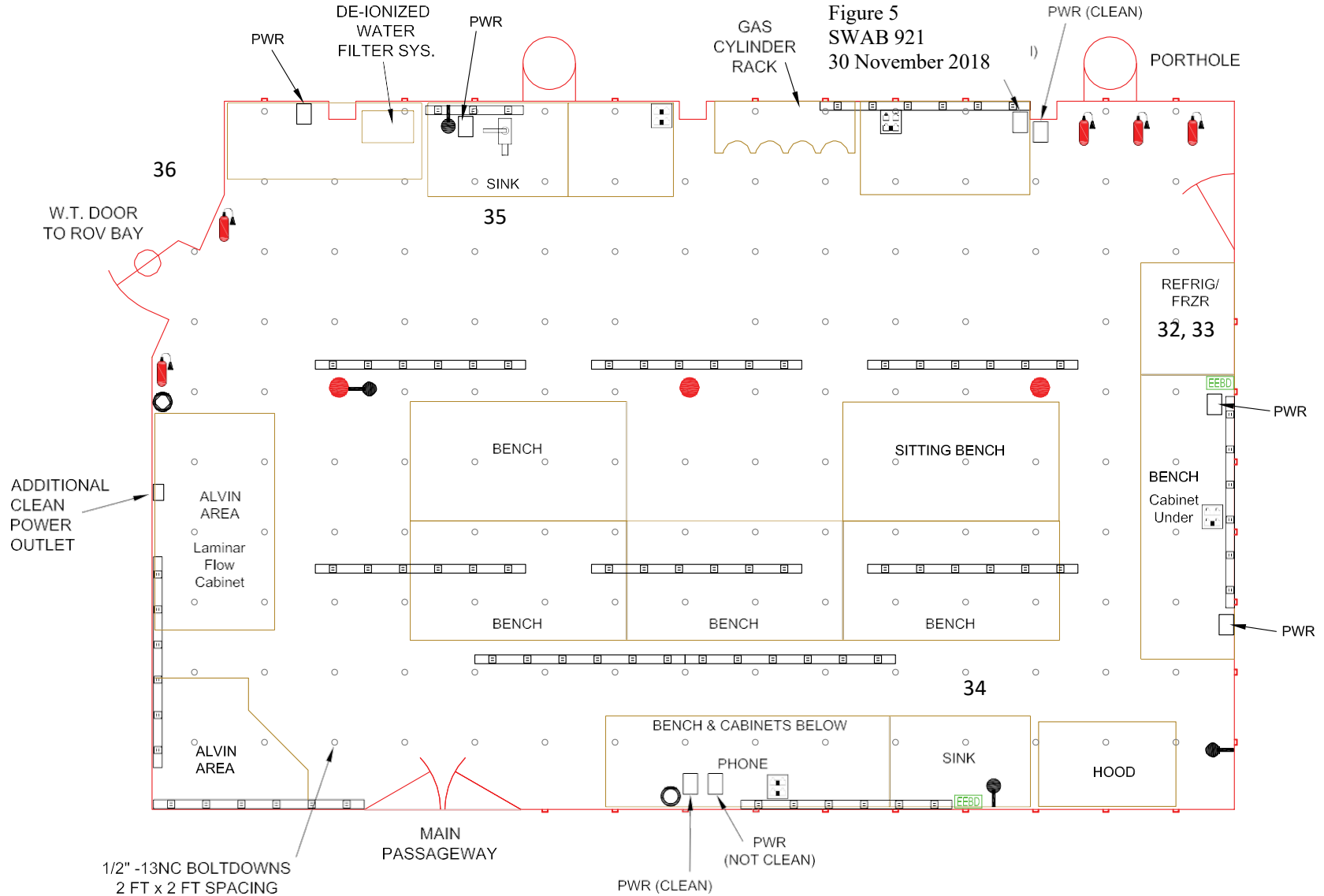





Figure 5  
SWAB 921  
30 November 2018



**HYDROGRAPHIC LABORATORY**  
*Atlantis Main Deck, Room 1-64-2*

FWD →

**KEY**

-  COMPUTER HUB
-  SHIP EQUIP -KEEP CLEAR
-  EMERGENCY ESCAPE BREATHING DEVICE
-  72" POWER STRIP, 6 PLUGS
-  FIRE EXTINGUISHER
-  SCIENCE SEA WATER
-  CABLE PASS THRU
-  COMPRESSED AIR

UNISTRUT:  
 BULKHEADS  
 2 FT SPACING  
 OVERHEAD FORE/AFT,  
 FULL LENGTH OF LAB  
 ALL POWER CLEAN UNLESS NOTED

Figure 6  
 SWAB 921  
 30 November 2018

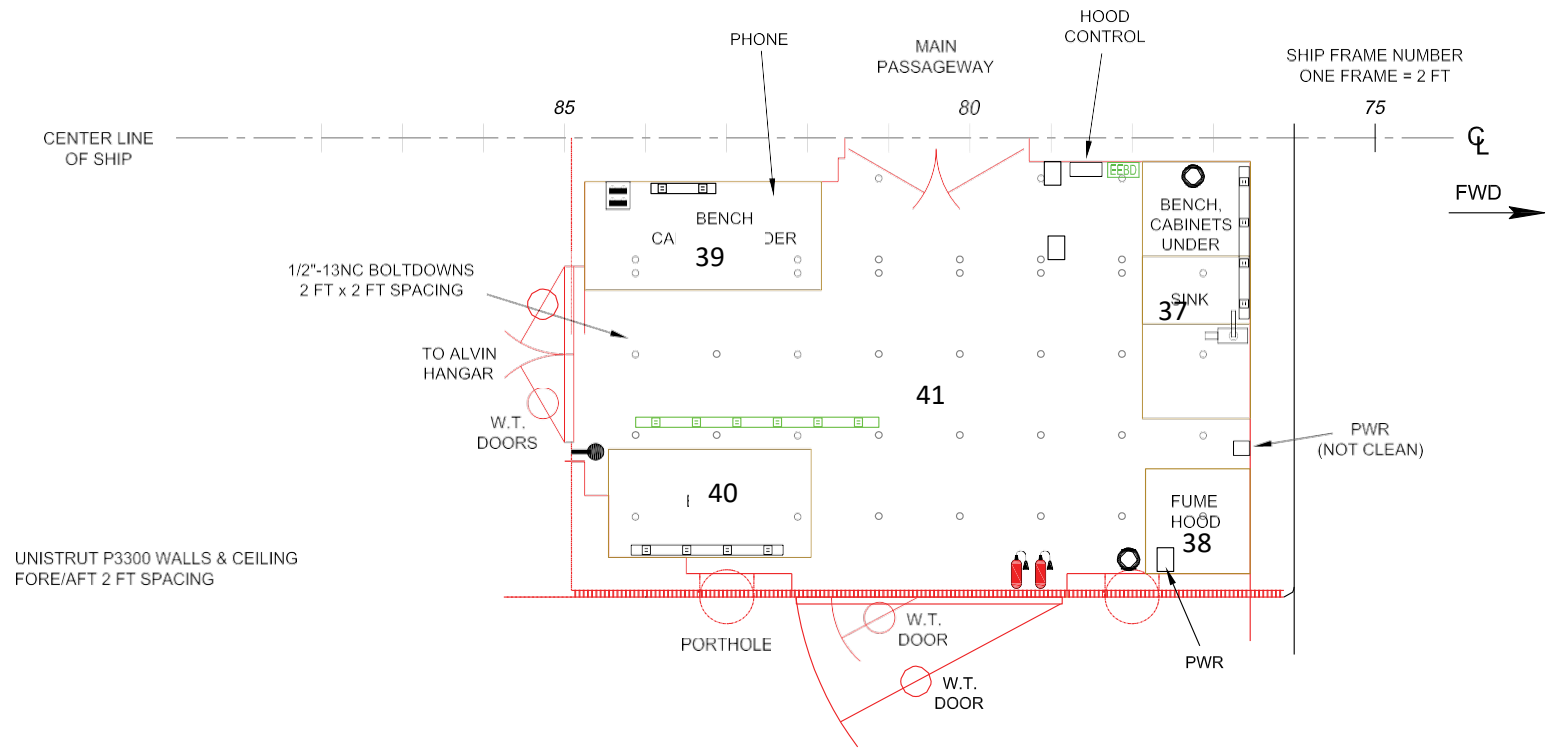

**WET LABORATORY**  
*Atlantis Main Deck, Rm 1-76-1*

# WHOI RADIOISOTOPE VAN

#625.6.03

Figure 7  
SWAB # 921  
30 November 2018

